

$$\vec{R} = u \vec{a} + v \vec{b}$$

$$\vec{R}_1 = 3\vec{a} + 2\vec{b}$$

$$\vec{R}_2 = -2\vec{a} - \vec{b}$$

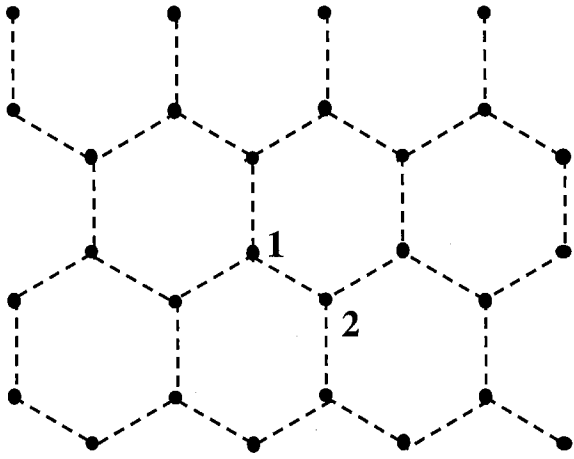

(a)

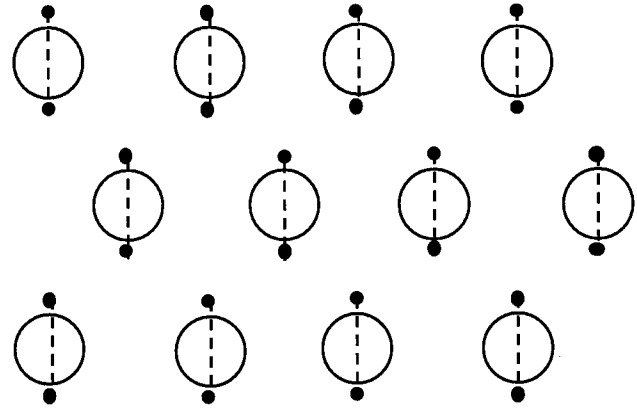

(b)

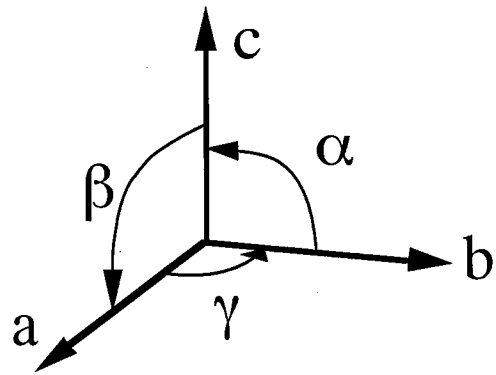

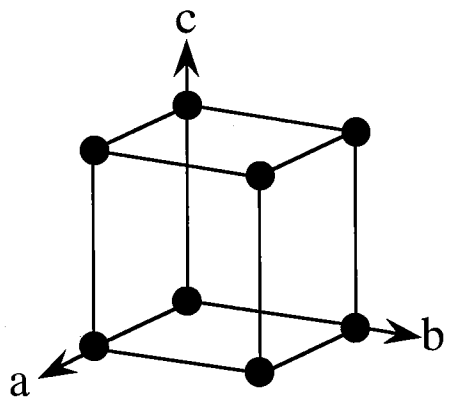

(a)

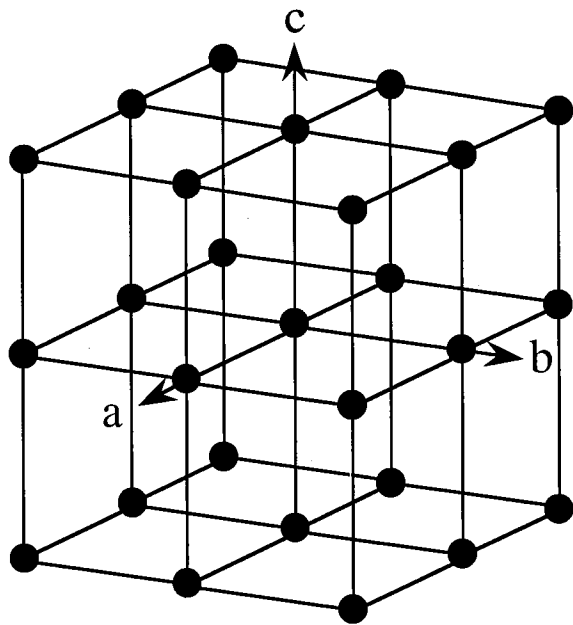

(b)

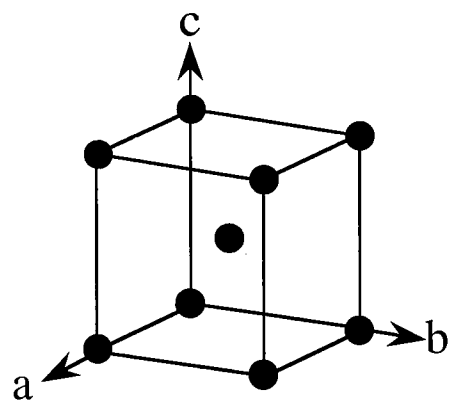

(a)

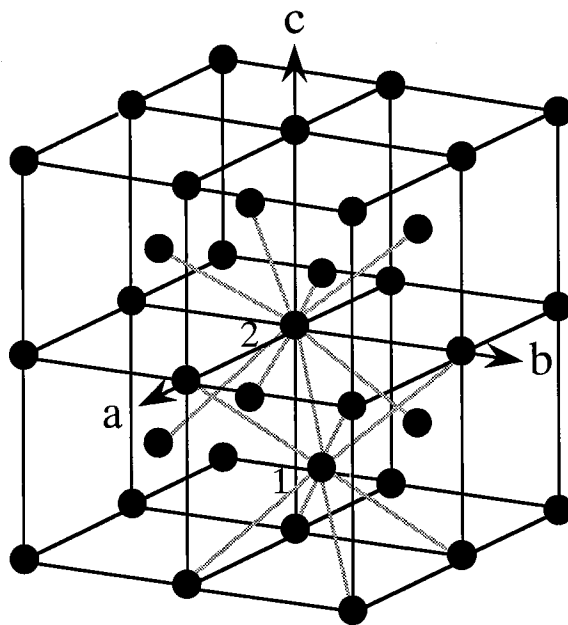

(b)

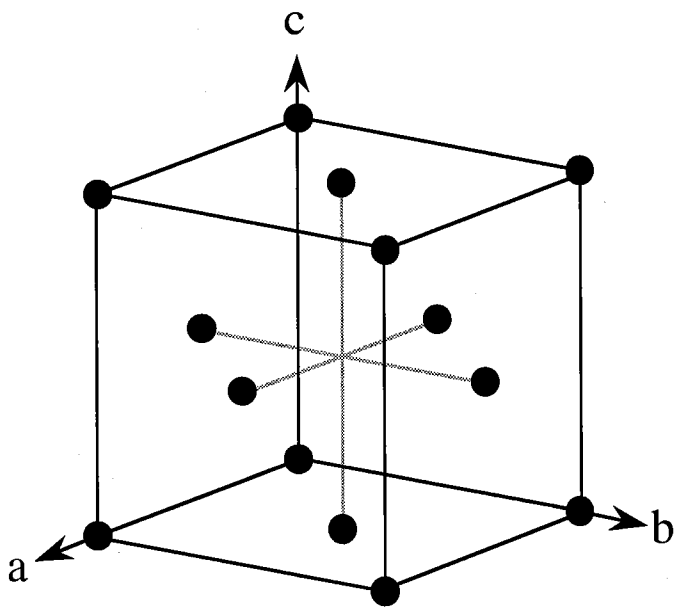

(a)

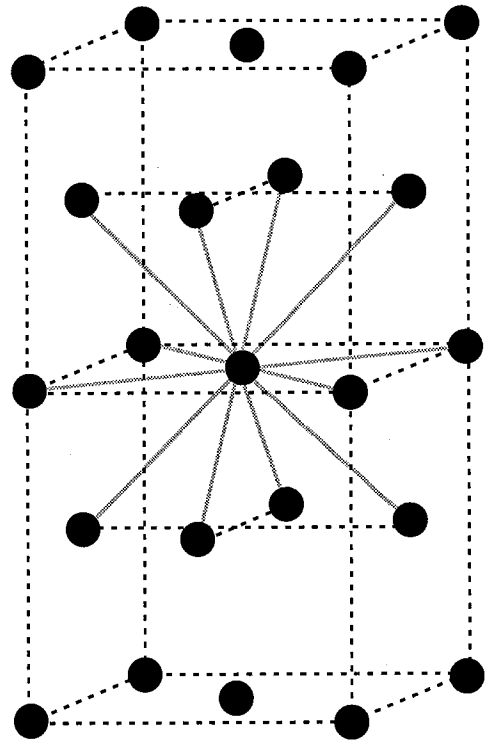

(b)

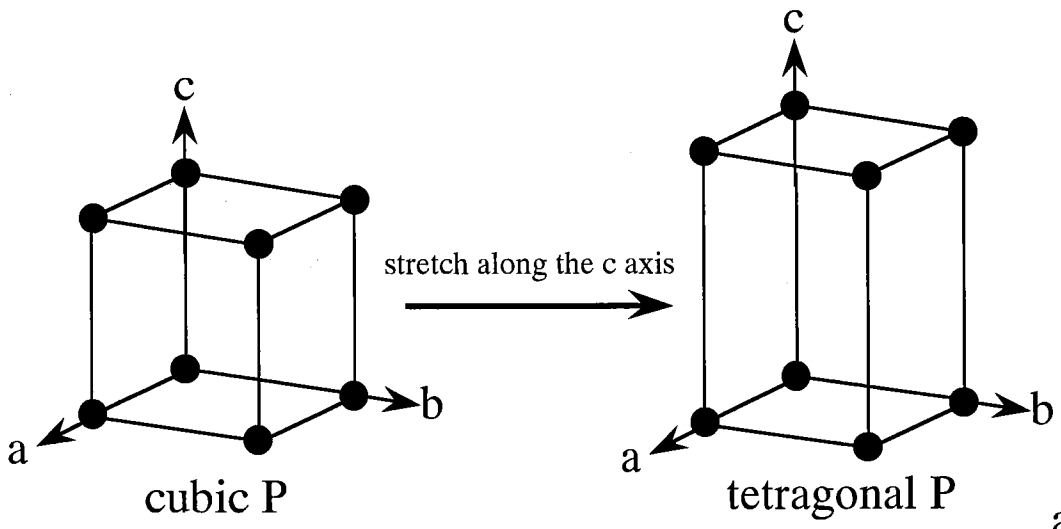

$$a = b \neq c$$

$$\alpha = \beta = \gamma = 90$$

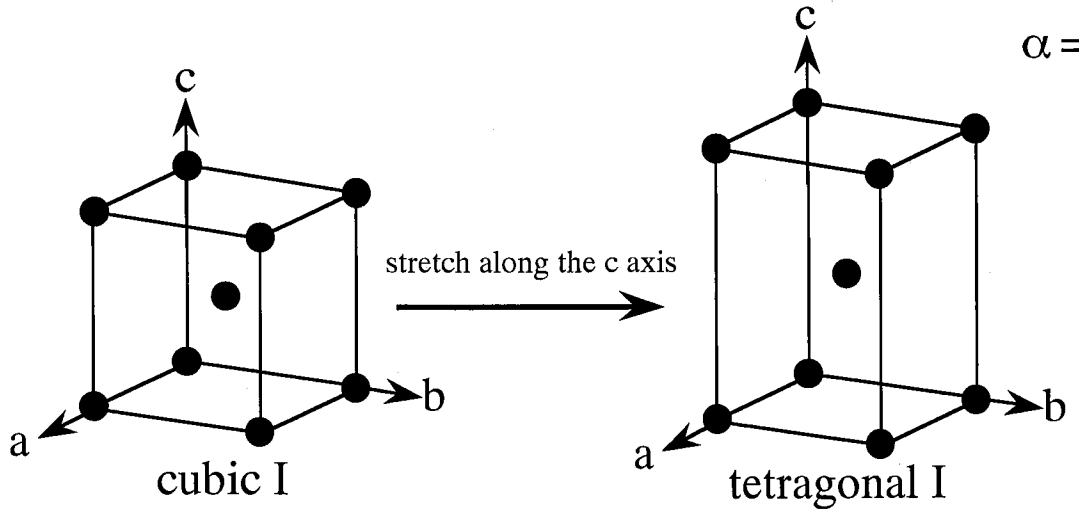

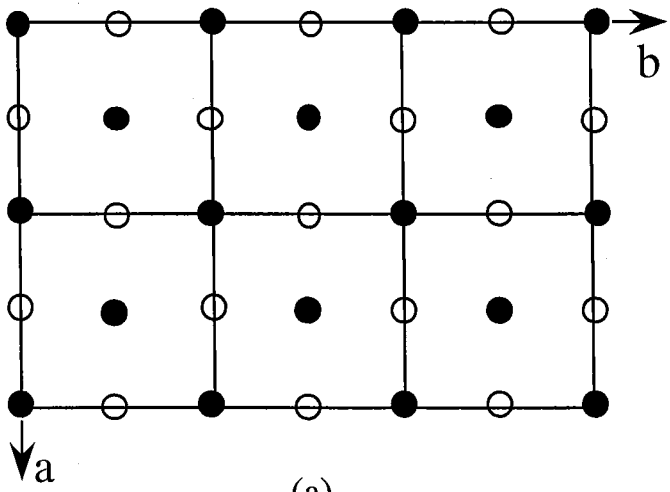

(a)

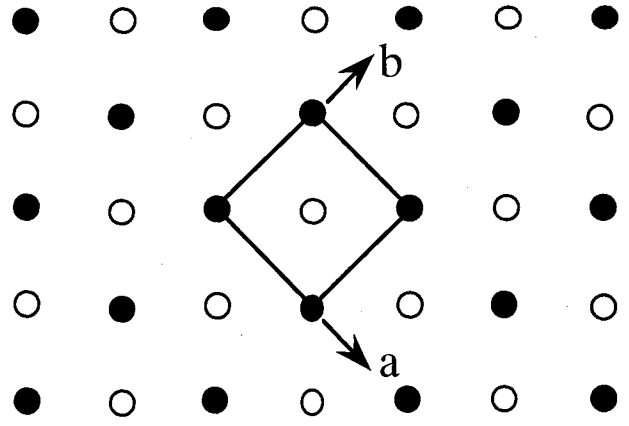

(b)

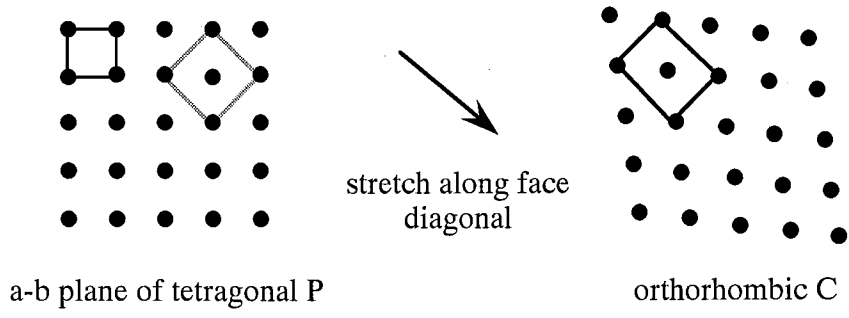

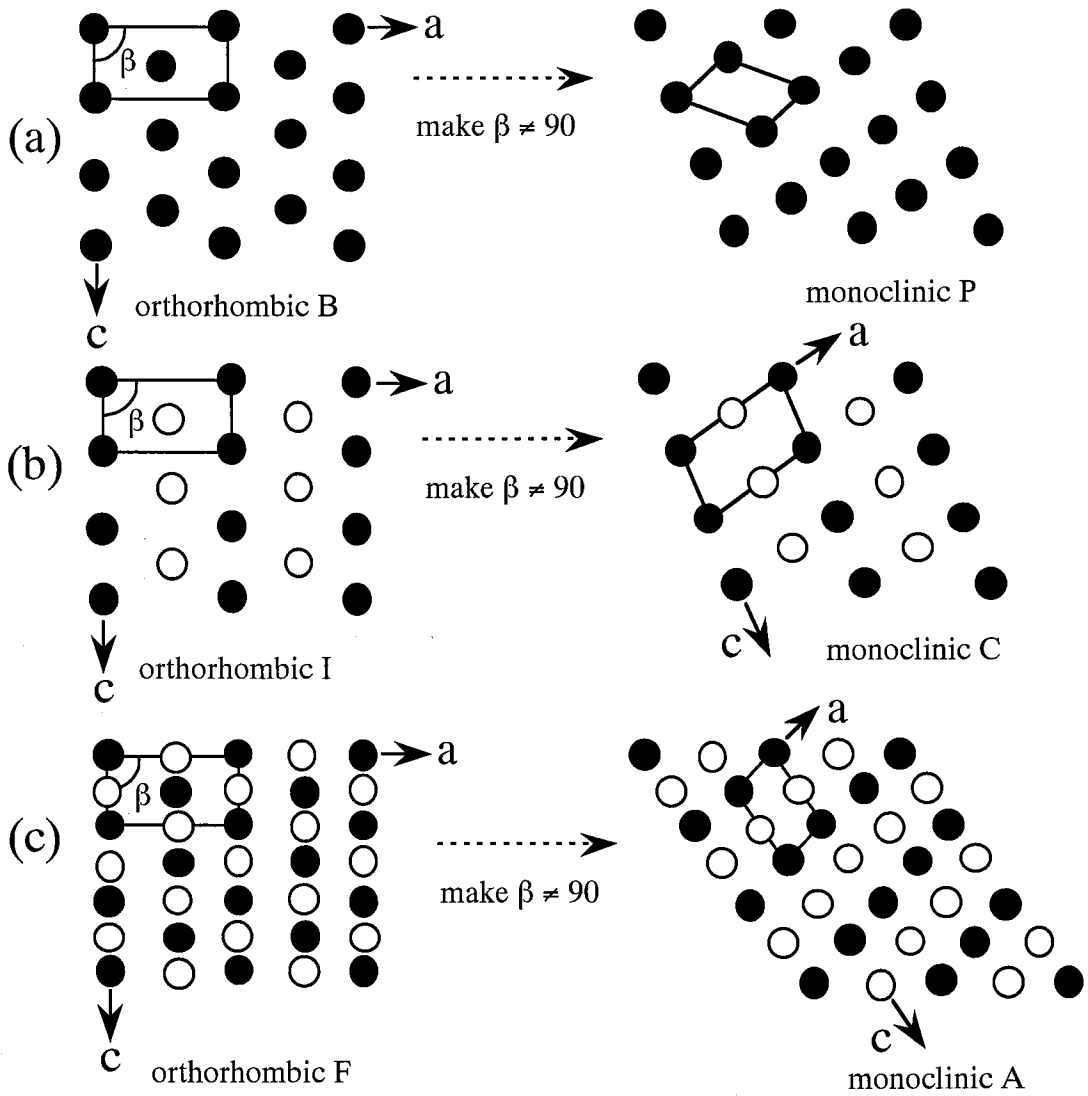

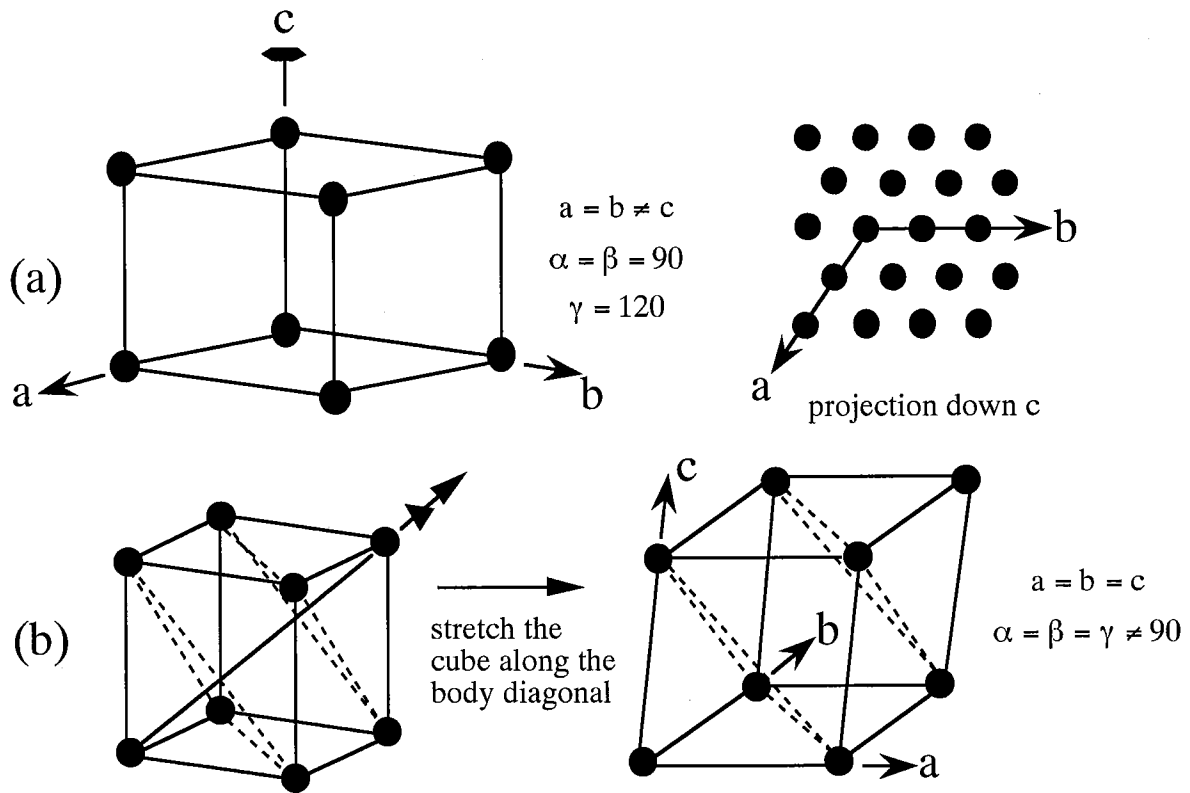

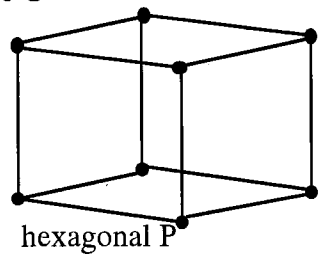
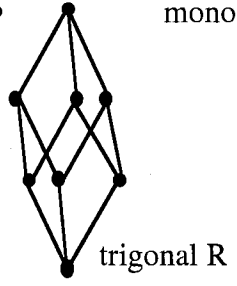
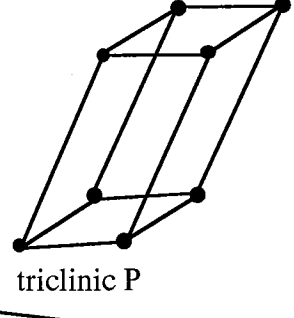
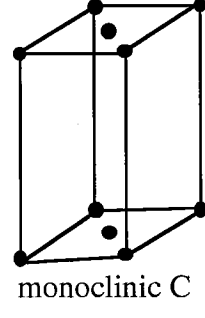
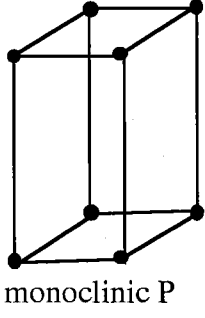
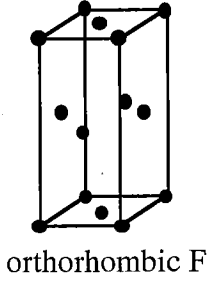
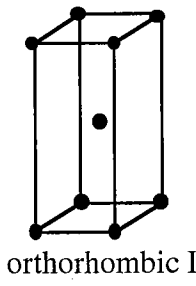
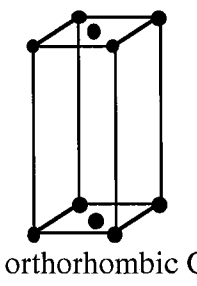
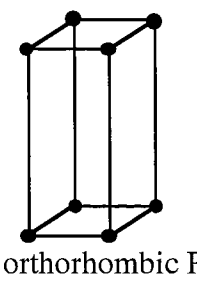
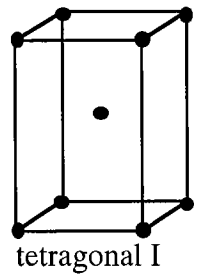
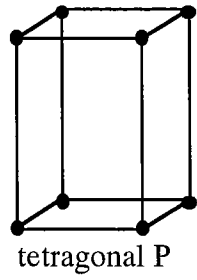
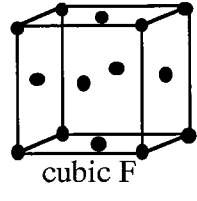
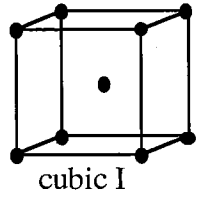
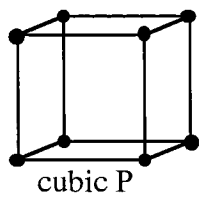

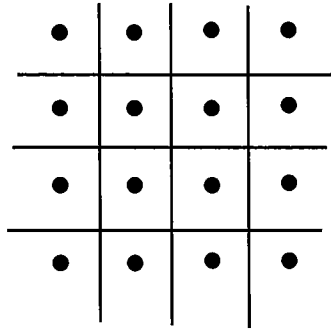

(a)

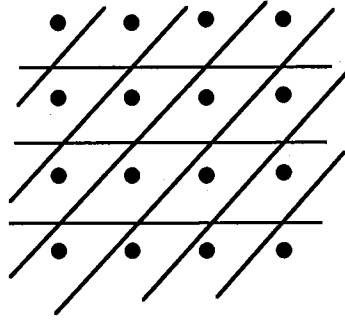

(b)

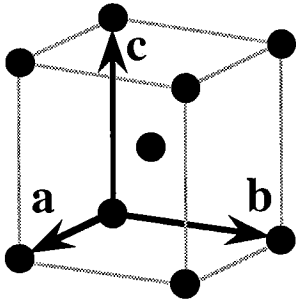

(a)

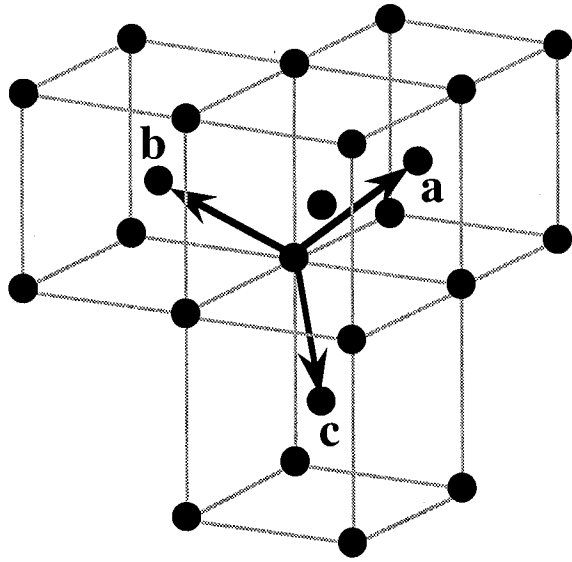

(b)

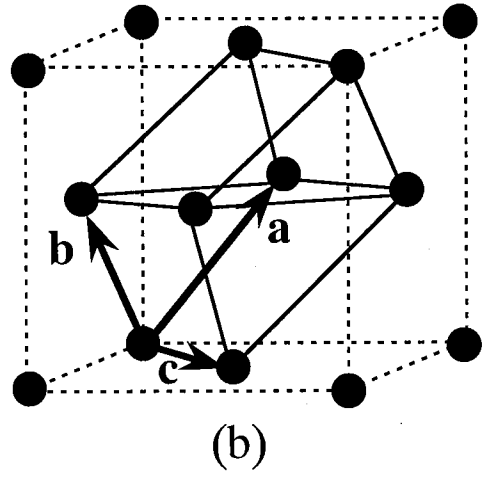
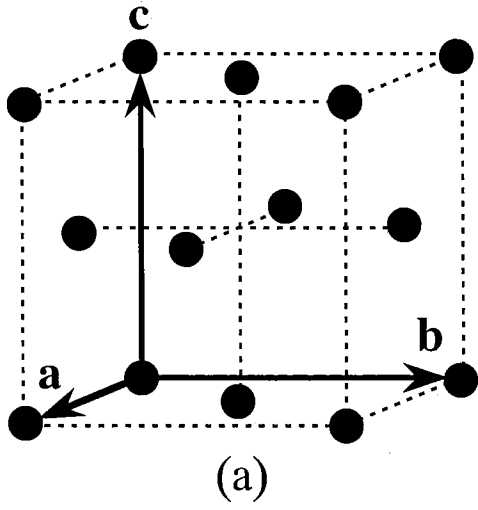

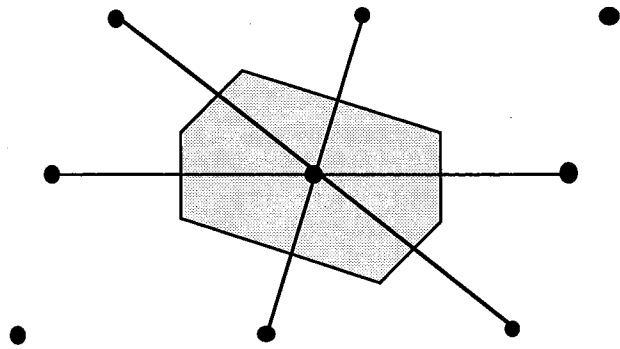

(a)

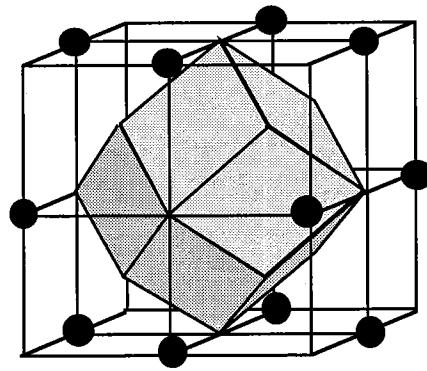

(b)

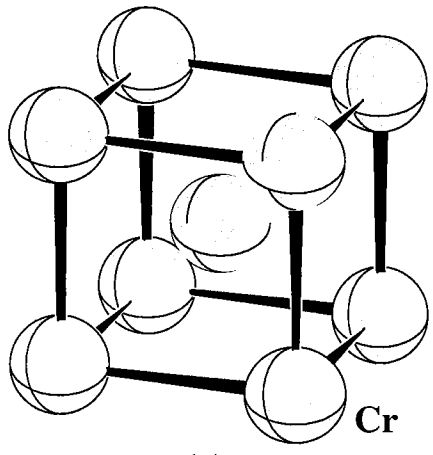

(a)

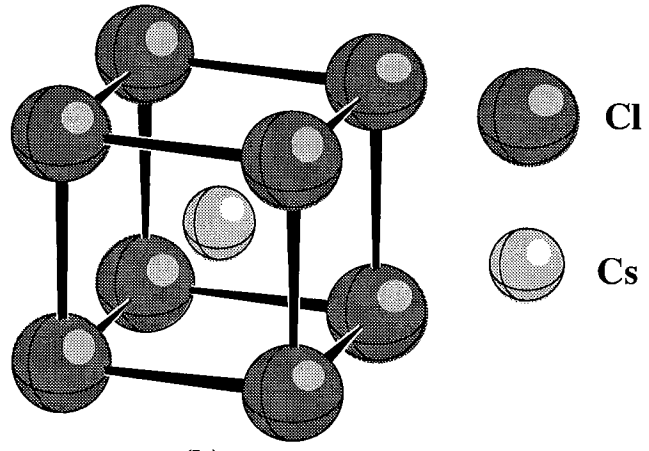

(b)

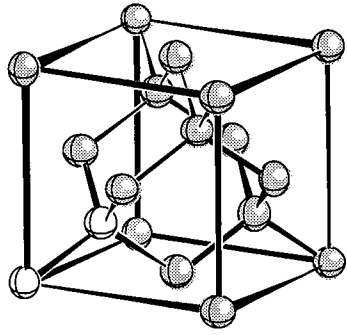

(a)

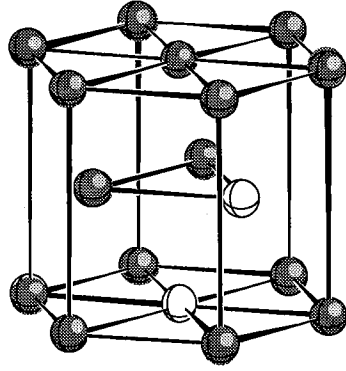

(b)

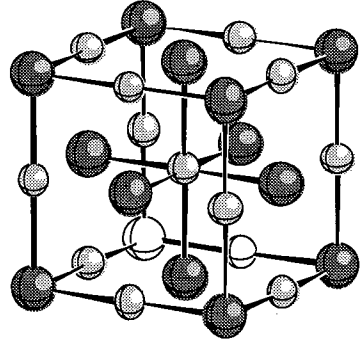

(c)

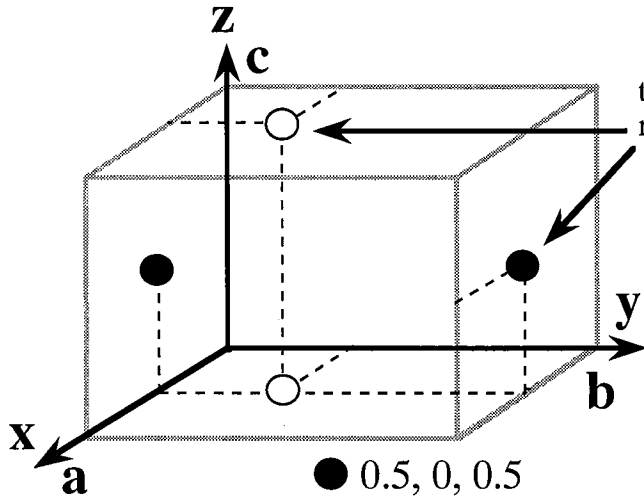

(a)

- $0.5, 0, 0.5$
- $0.5, 0.3, 0$

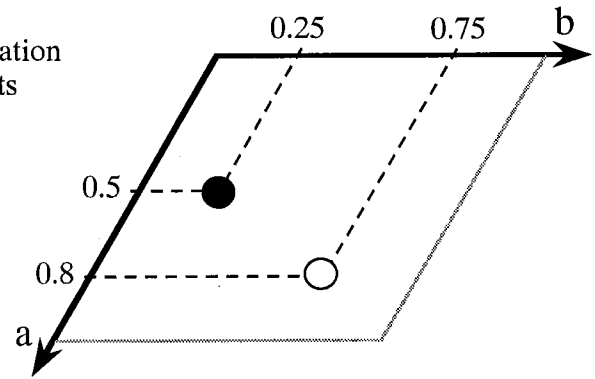

(b)

- $(0.8, 0.75, 0)$
- $(0.5, 0.25, 0)$

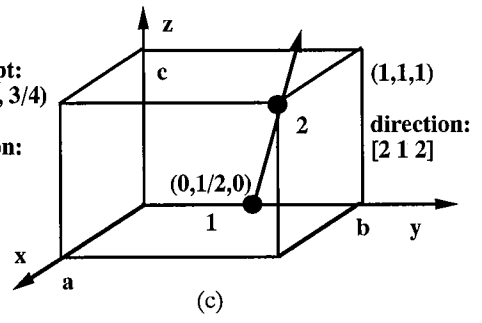
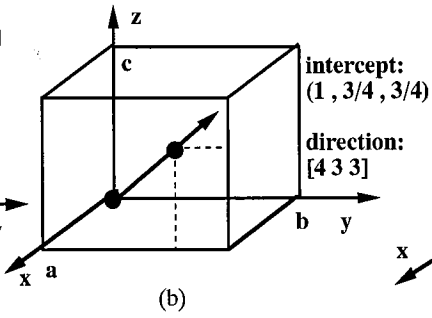
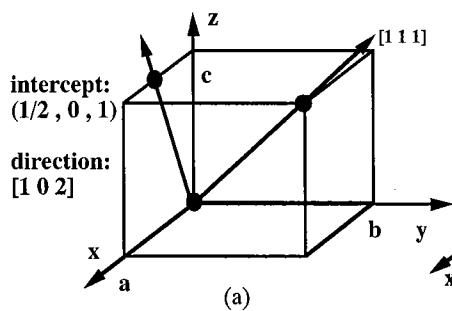

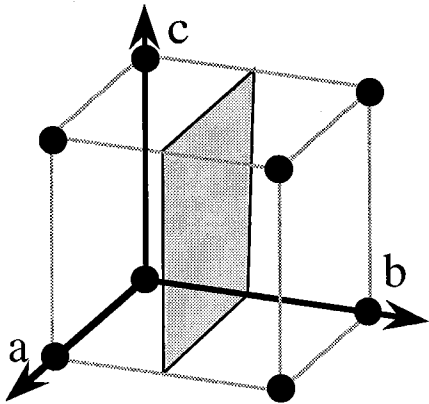

intercepts: $(-, 1/2, -)$
index: $(0\ 2\ 0)$

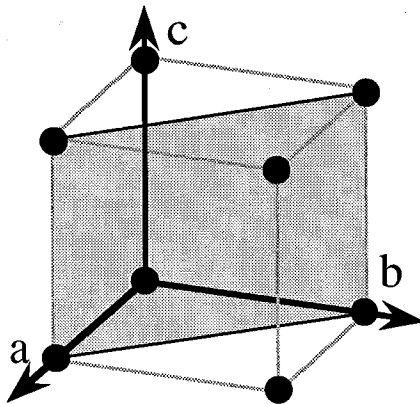

intercepts: $(1, 1, -)$
index: $(1\ 1\ 0)$

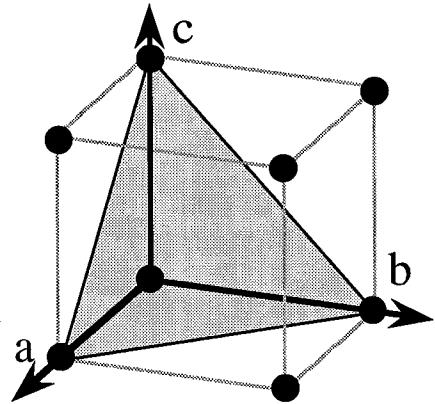

intercepts: $(1, 1, 1)$
index: $(1\ 1\ 1)$

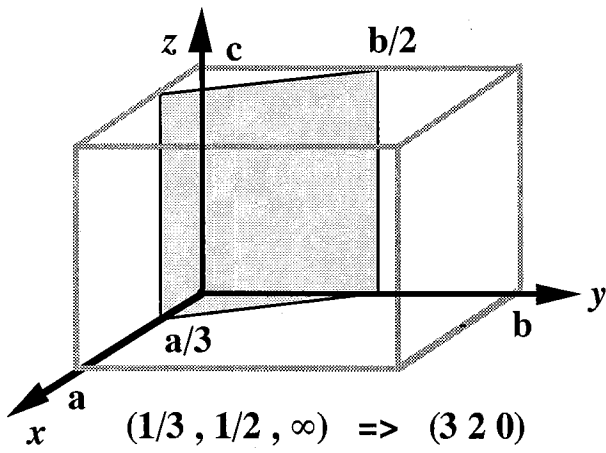

(a)

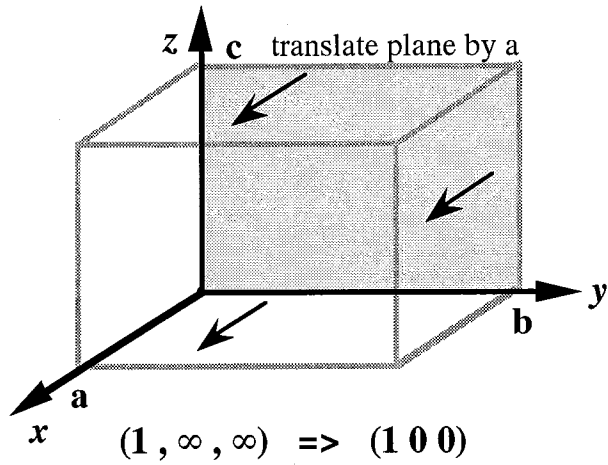

(b)

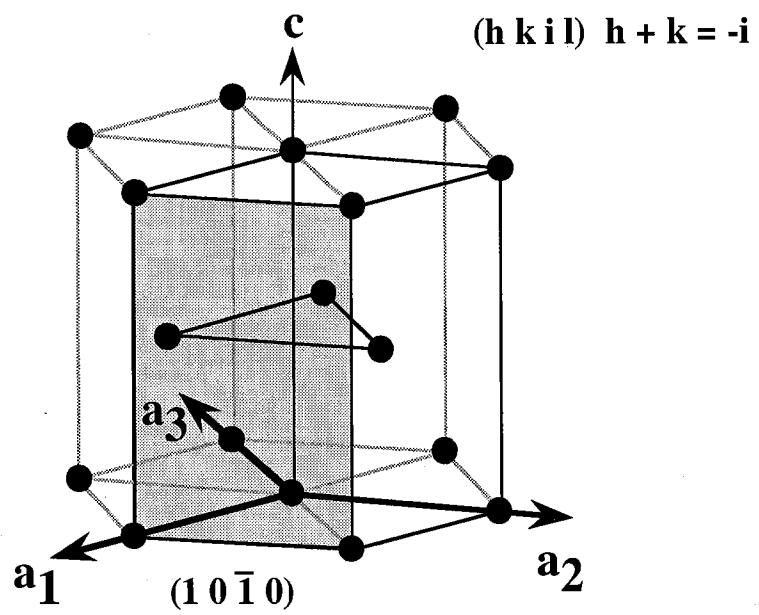

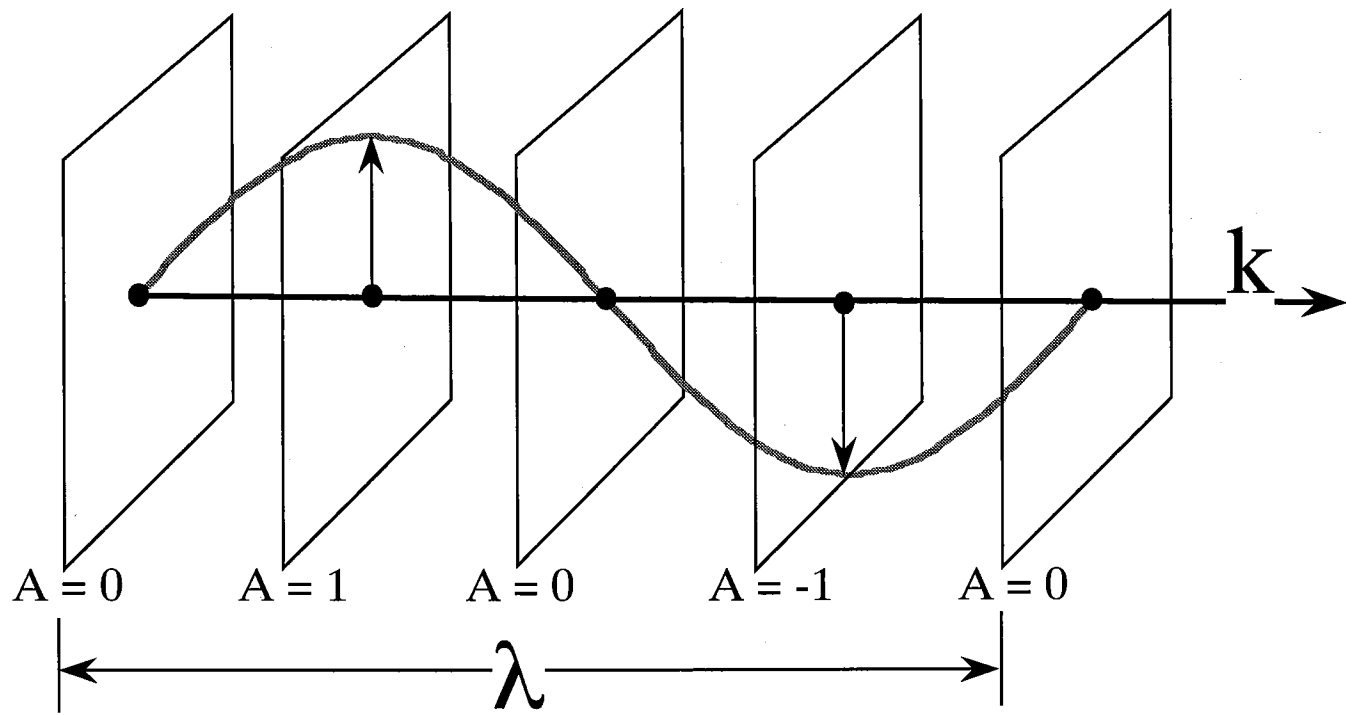

2.24

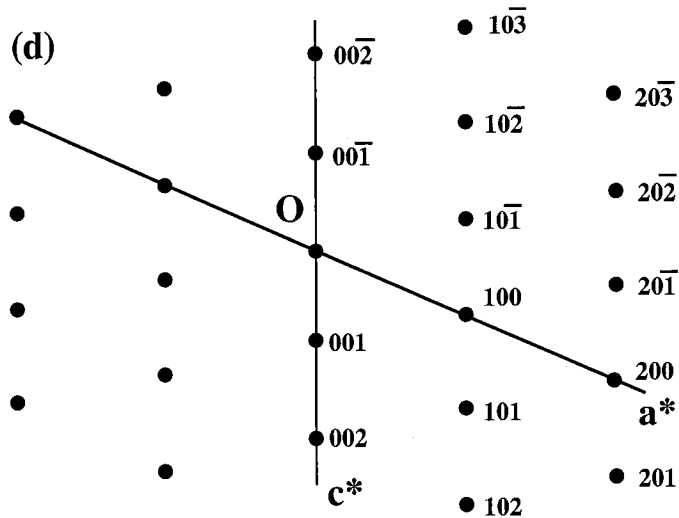
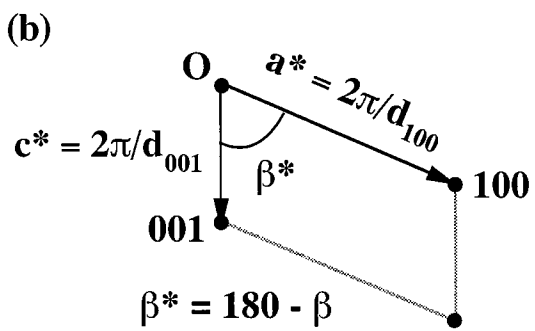
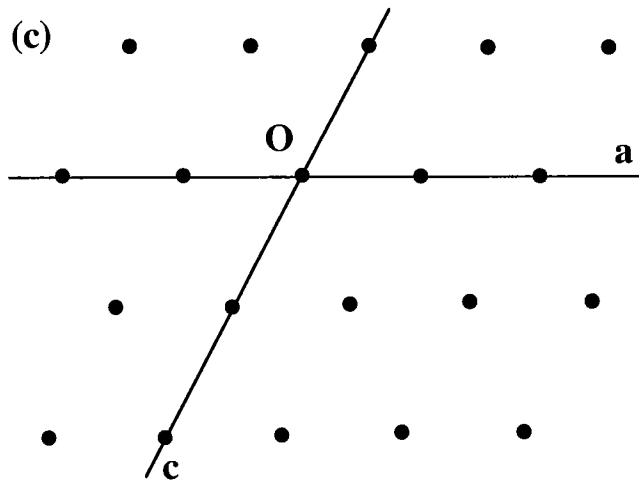
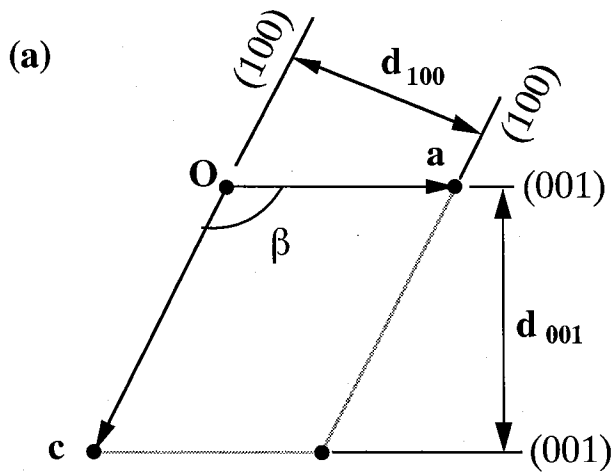

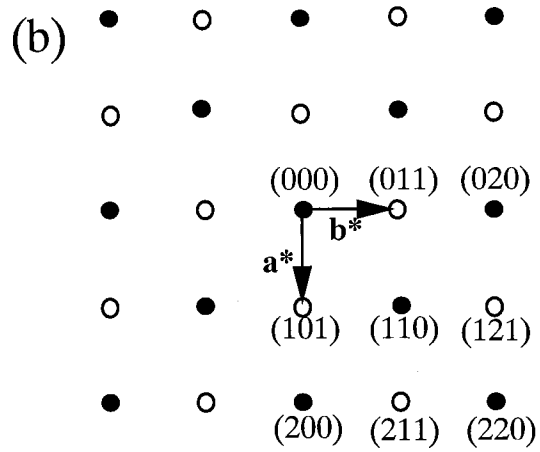
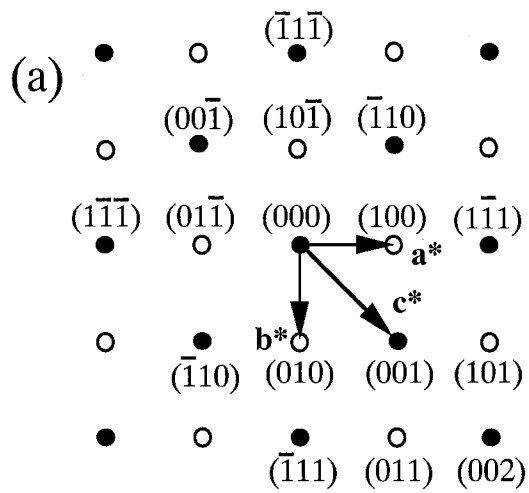

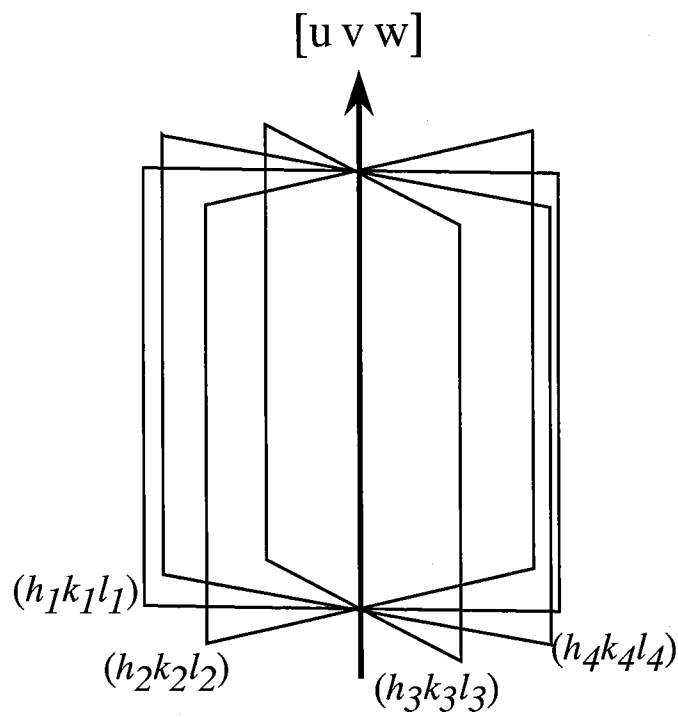

2127

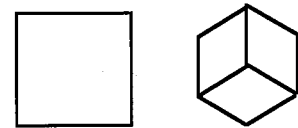
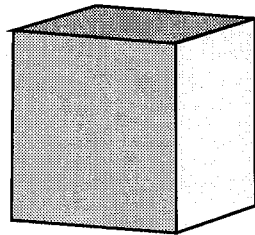
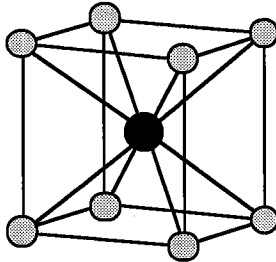
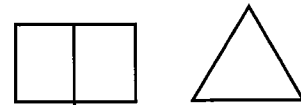
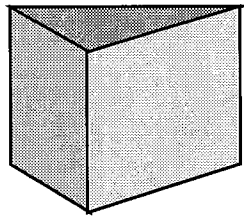
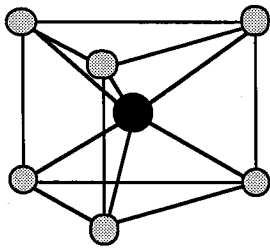
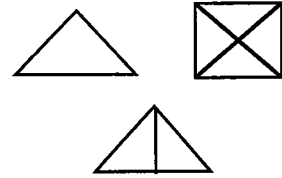
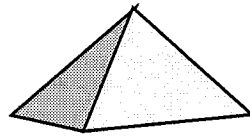
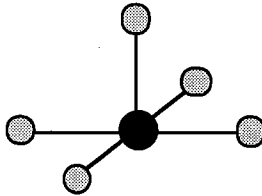
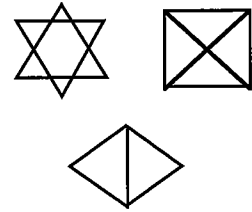
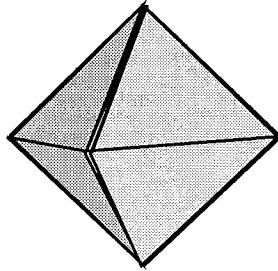
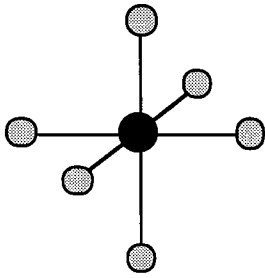
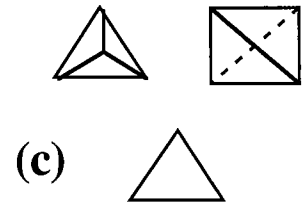
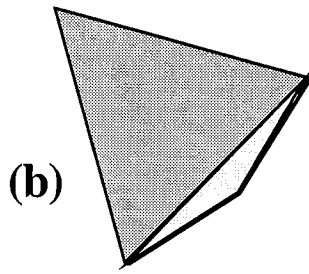
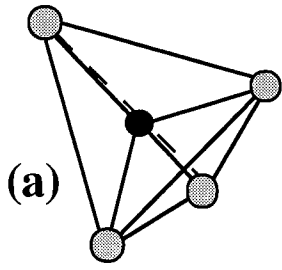

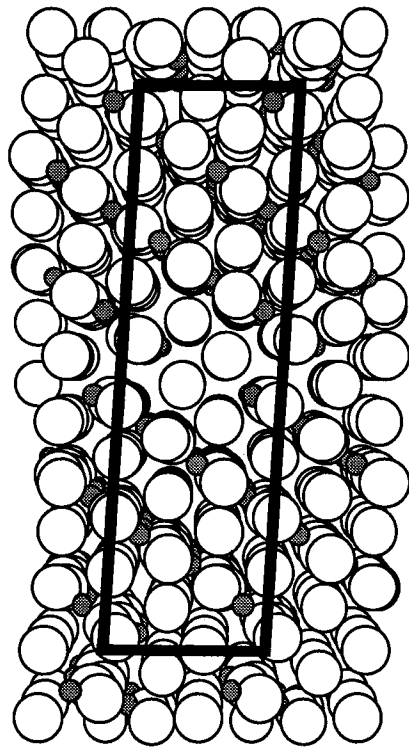

(a)

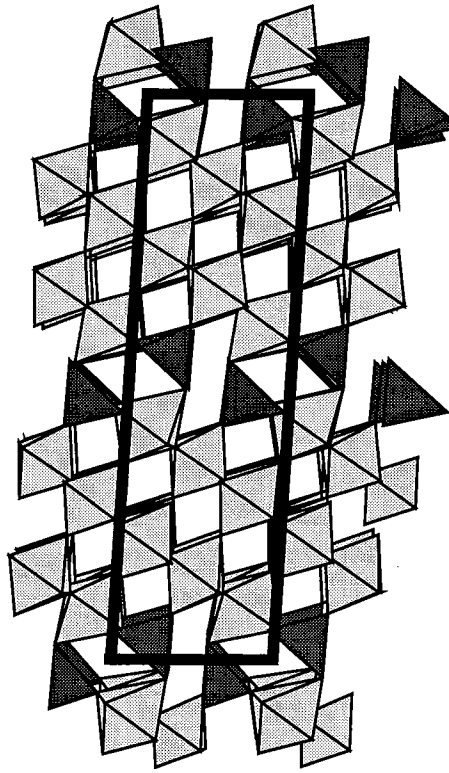

(b)

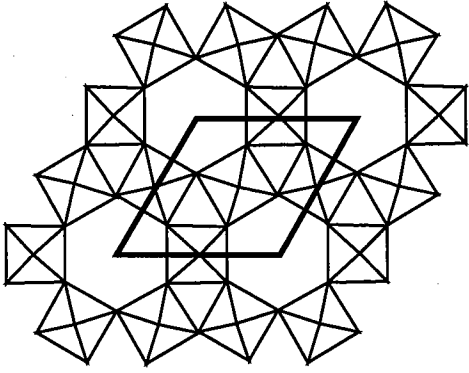

(a)

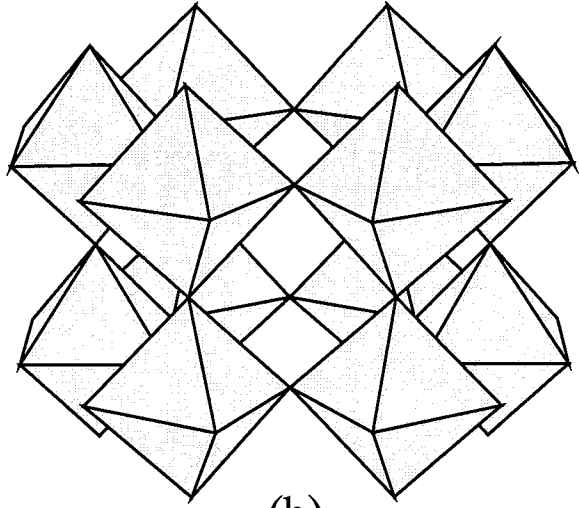

(b)

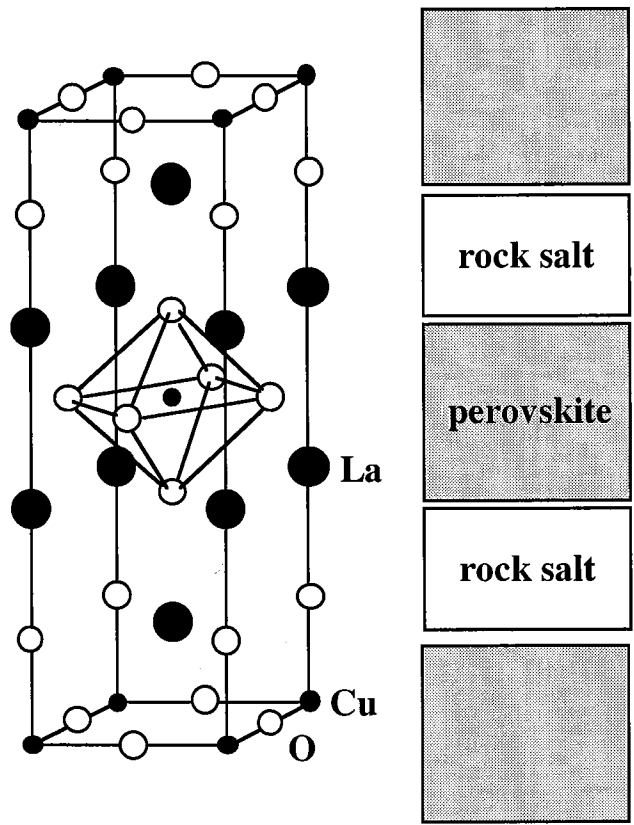

2.31

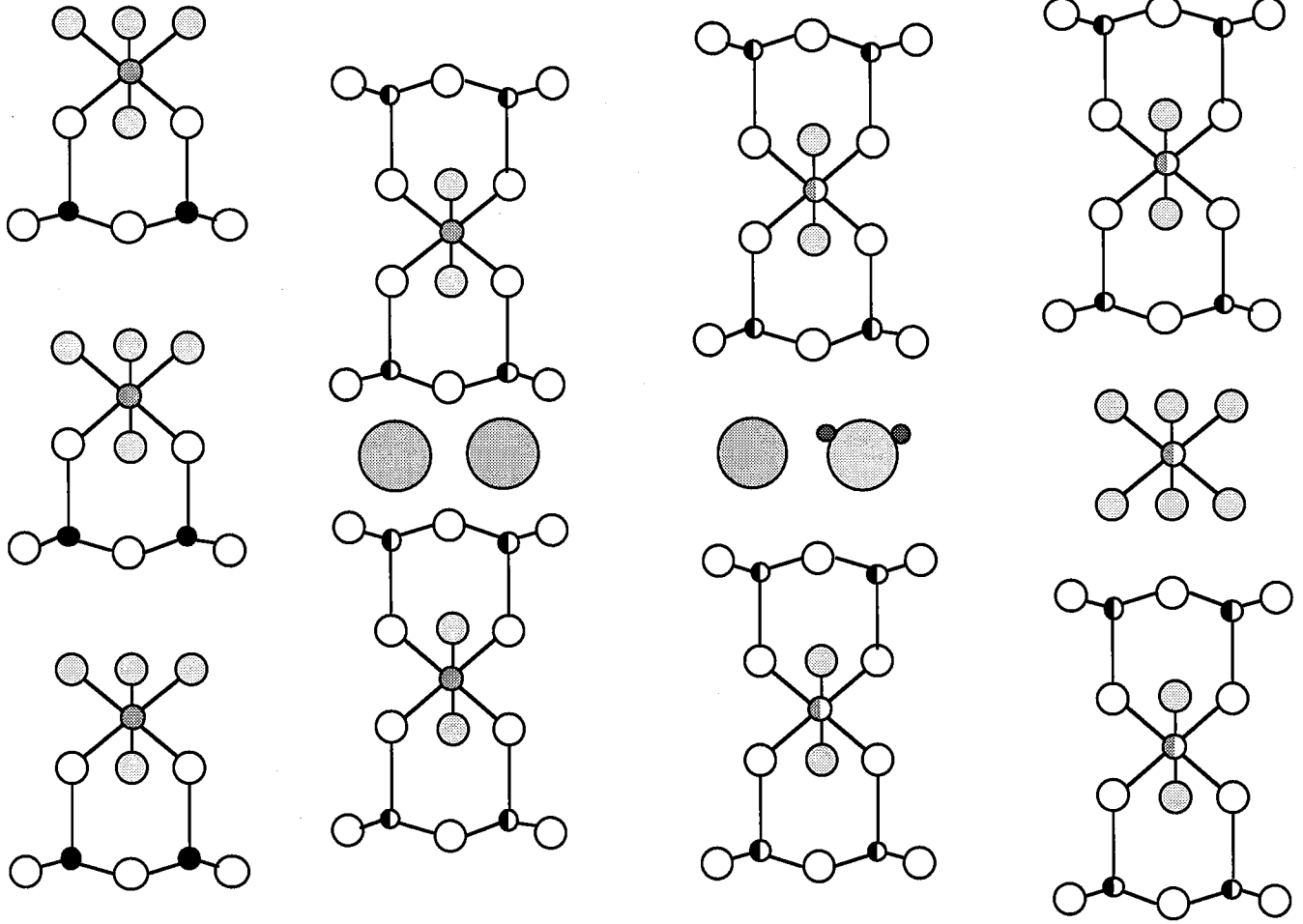

● Si ○ O ● OH ● Al ● Si-Al ○ Al-Mg ● K ● H₂O

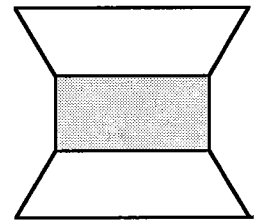
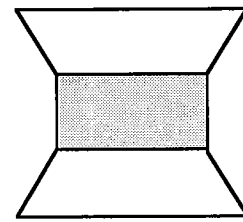
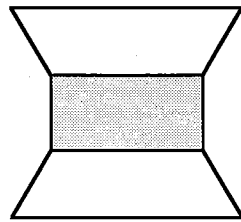
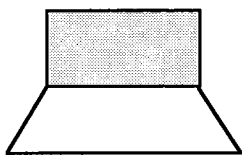
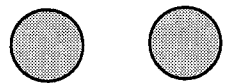
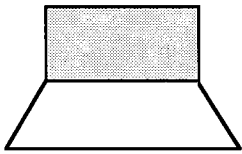
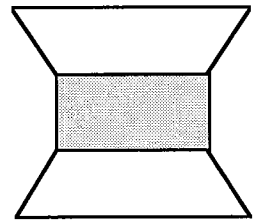
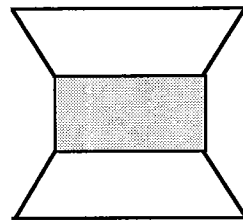
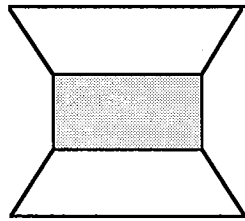
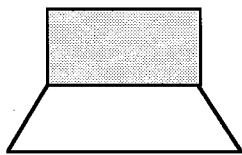

Kaolinite

**Muscovite
(mica)**

Montmorillonite

Chlorite

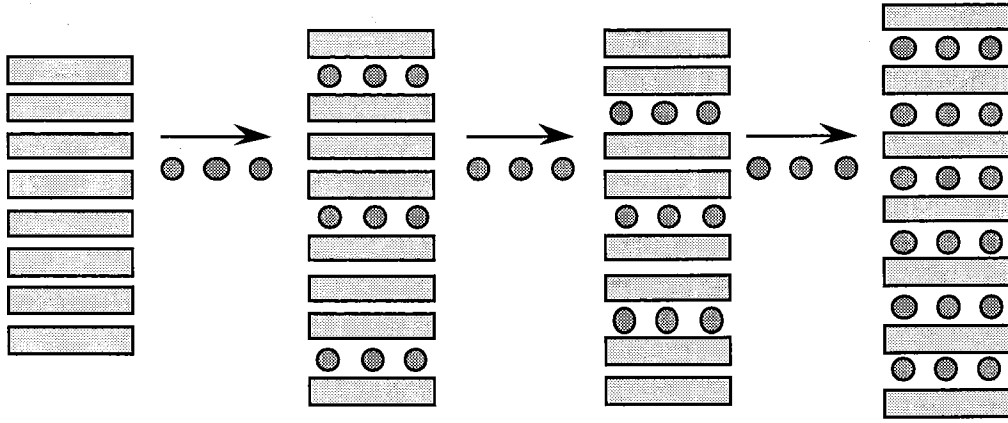

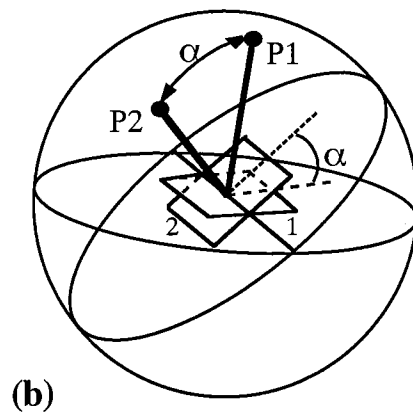
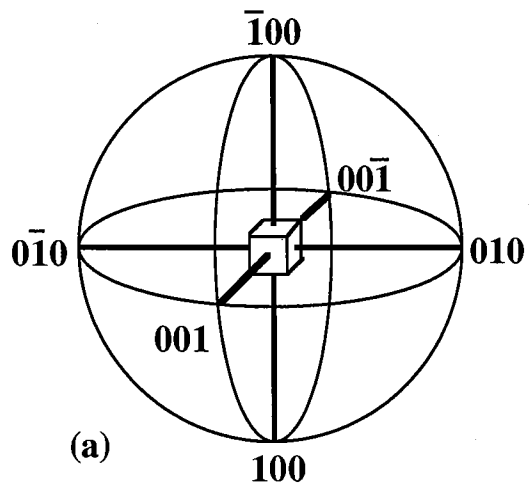

2.34

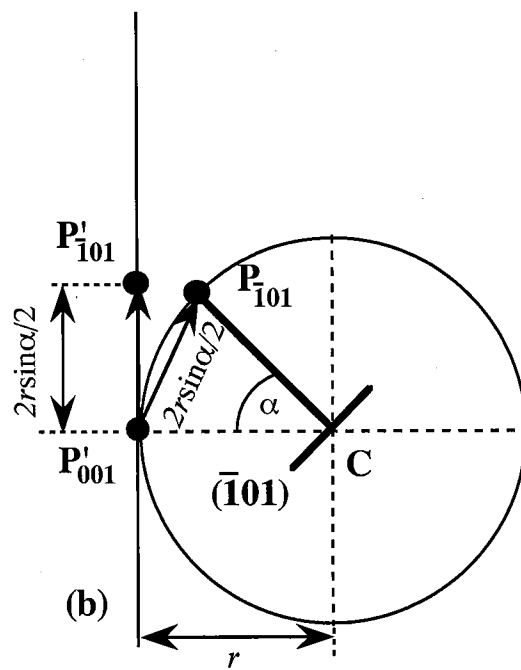
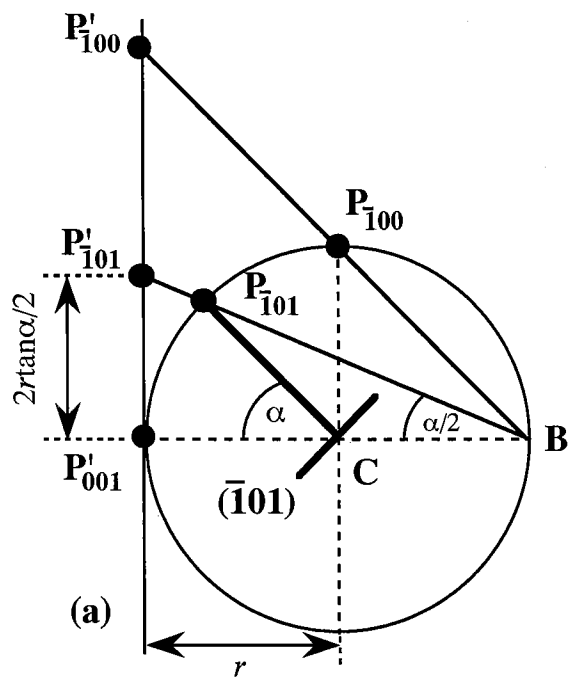

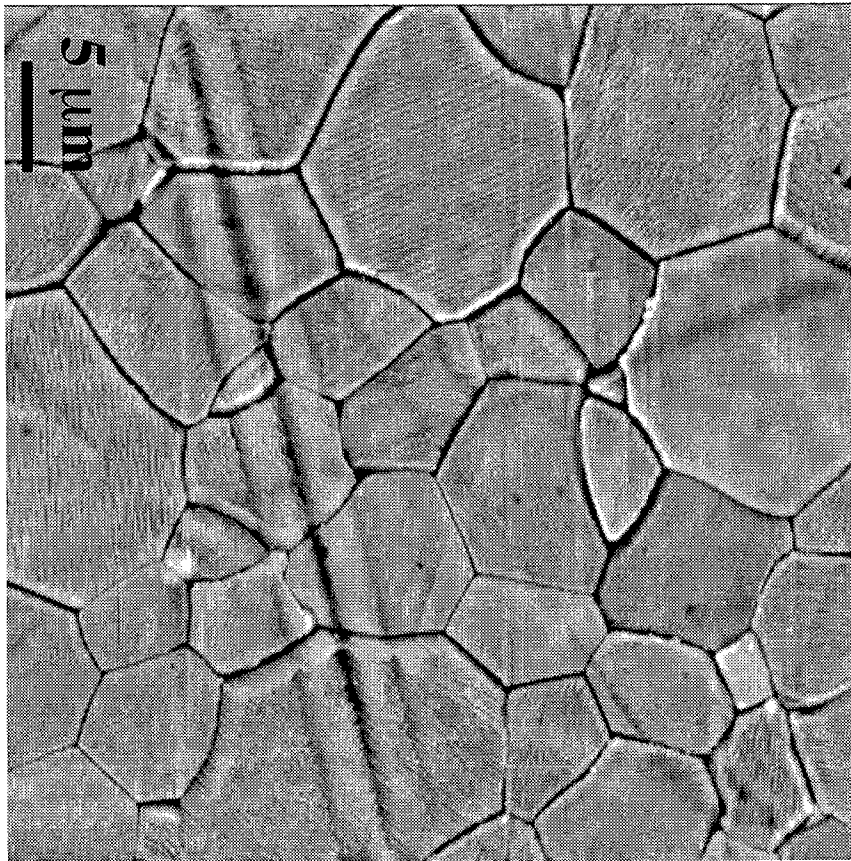

2.37

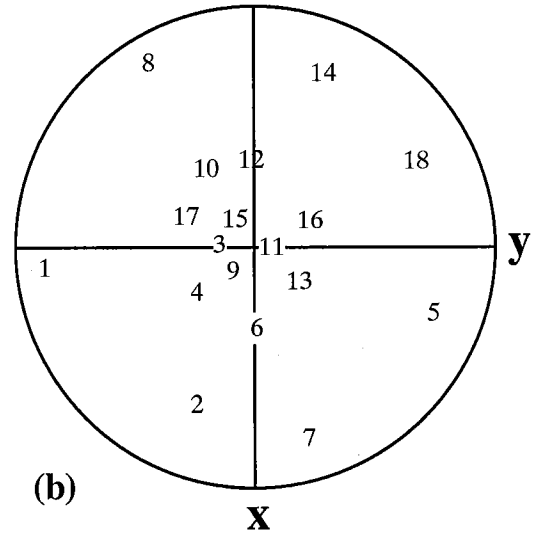
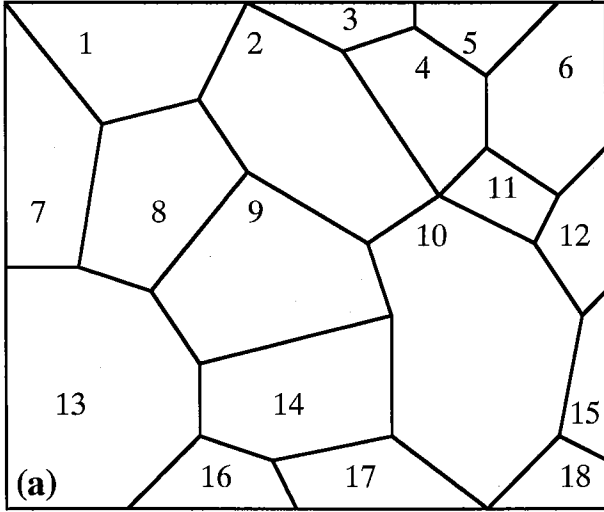

2.38

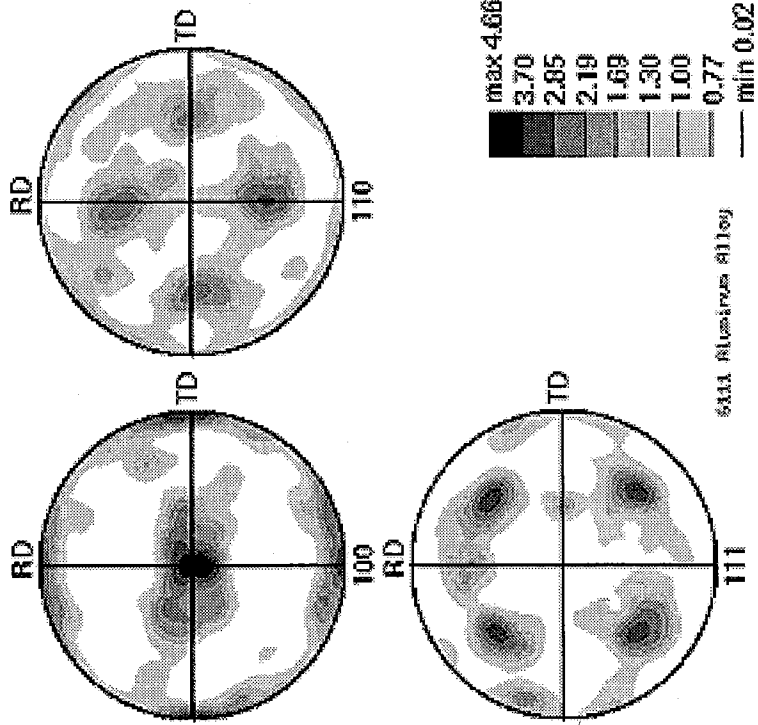

2.39

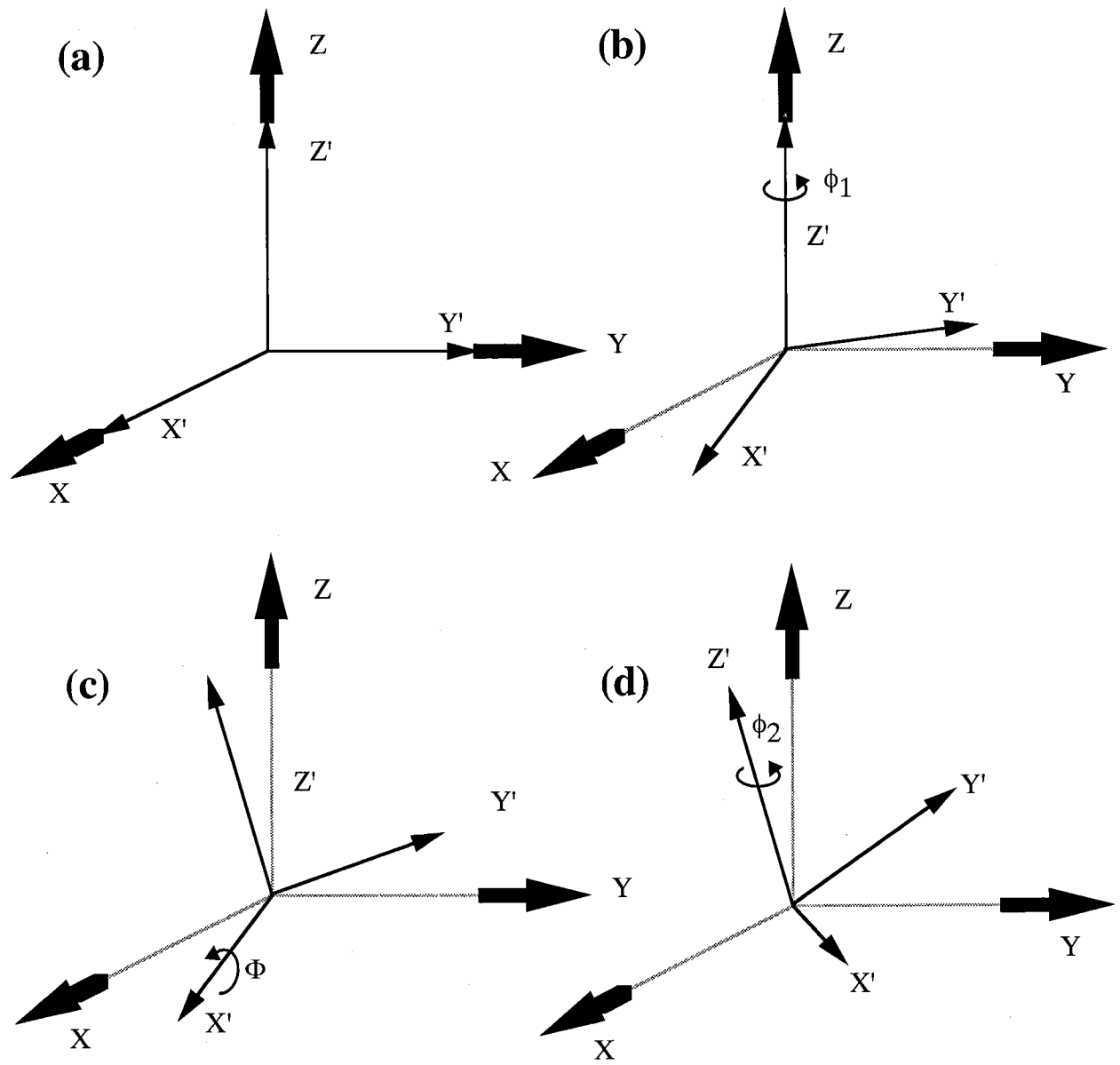

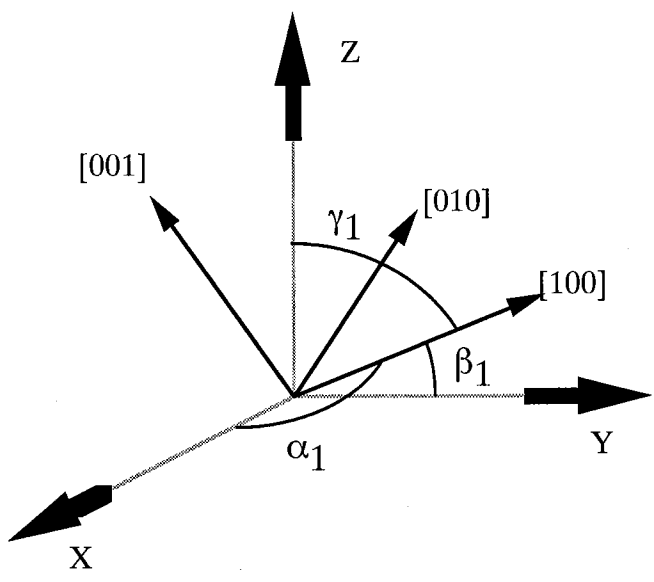

2.41

2.4.2

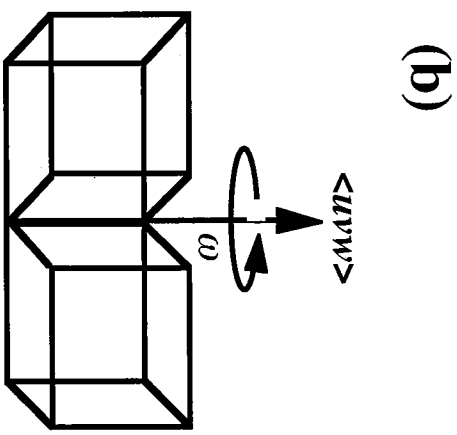
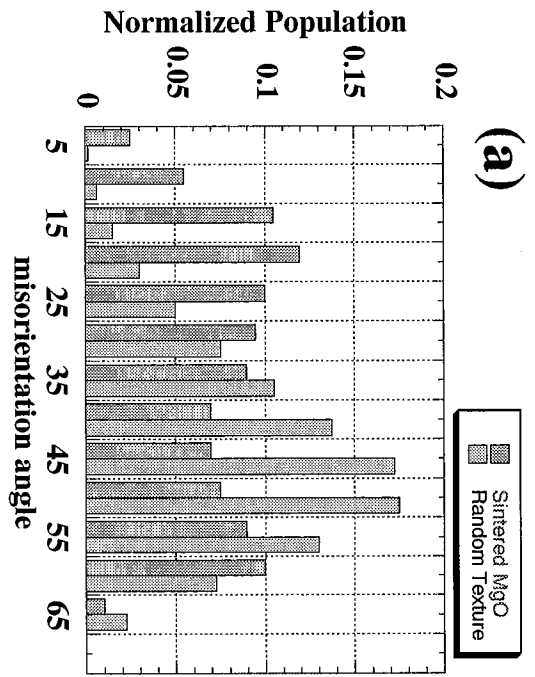

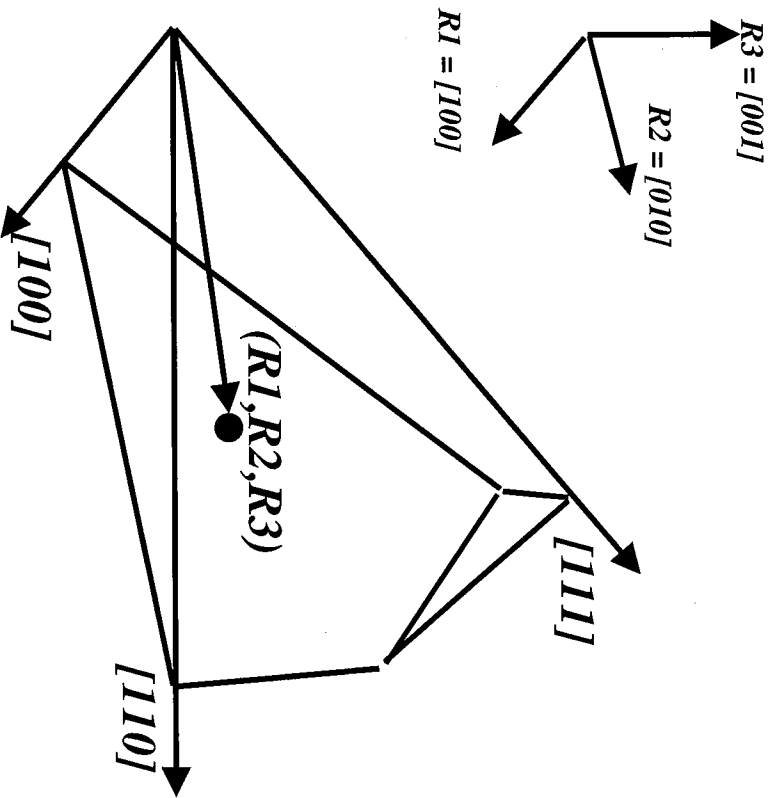

2.43

2.44

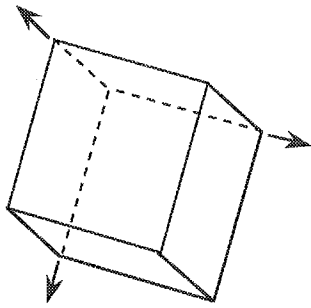
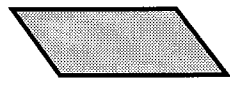
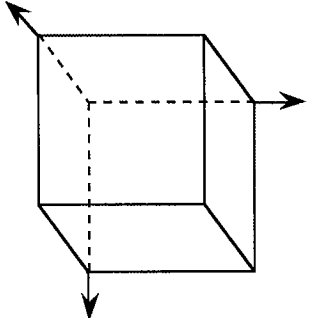
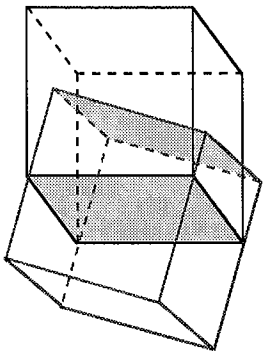

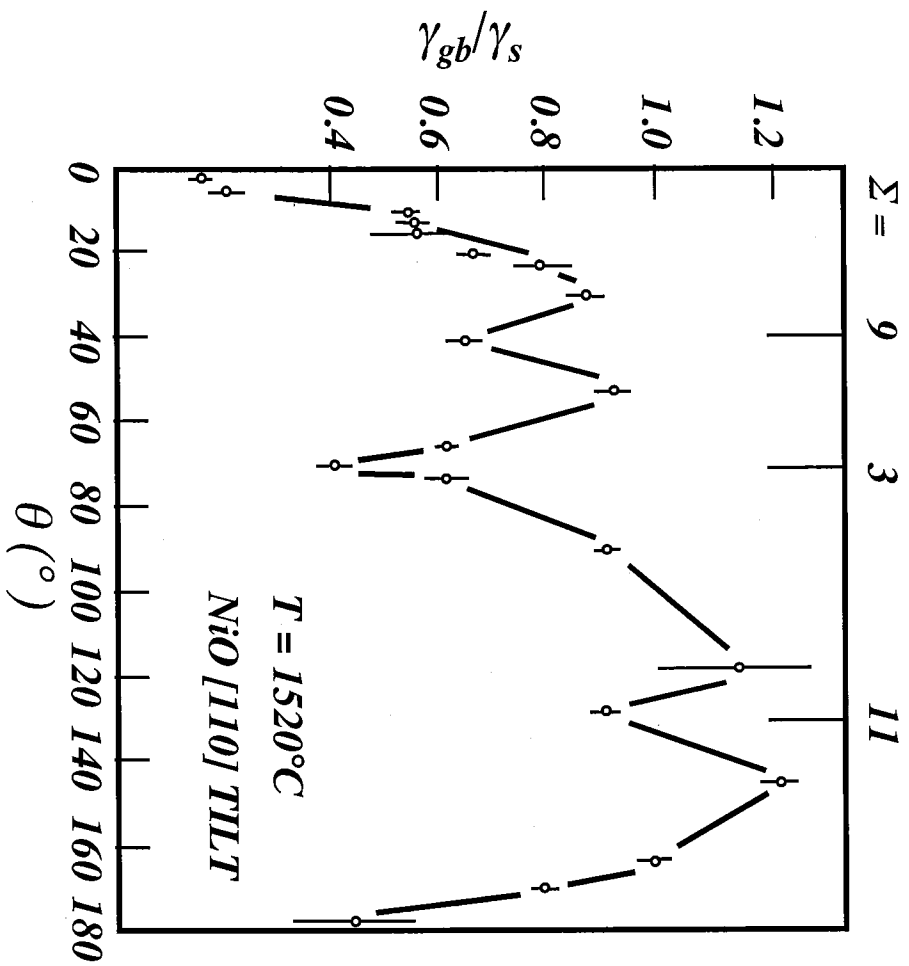

2.95

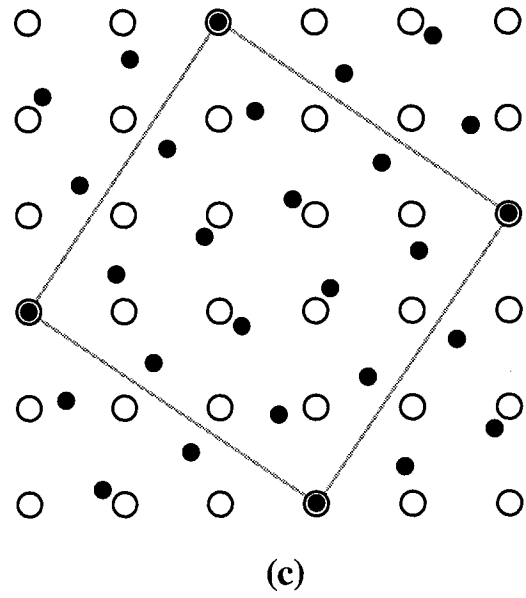
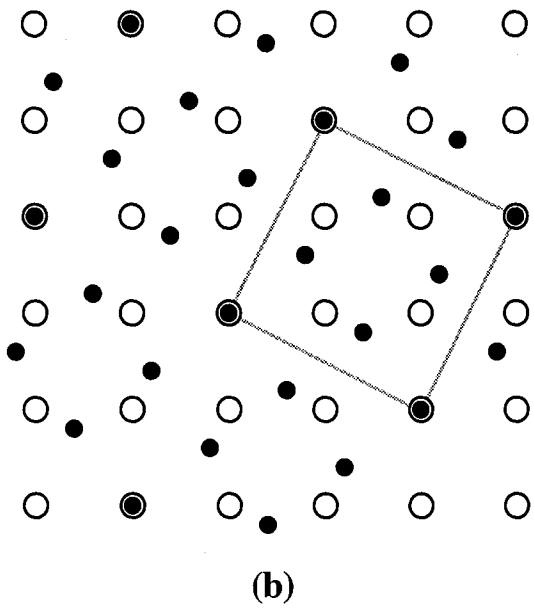
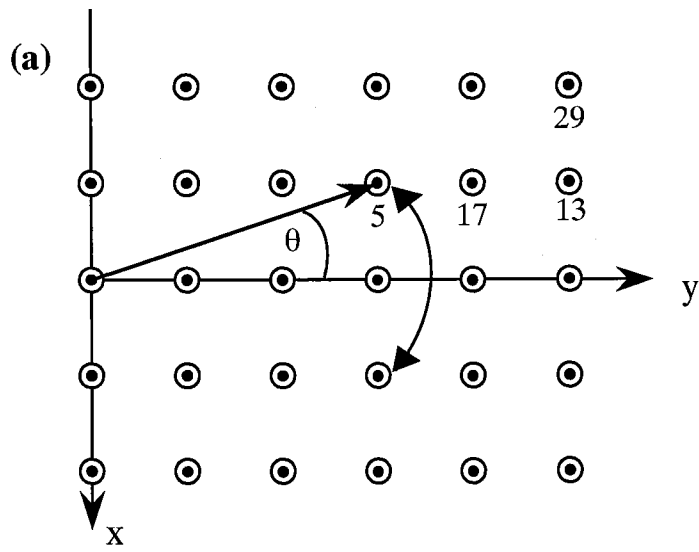

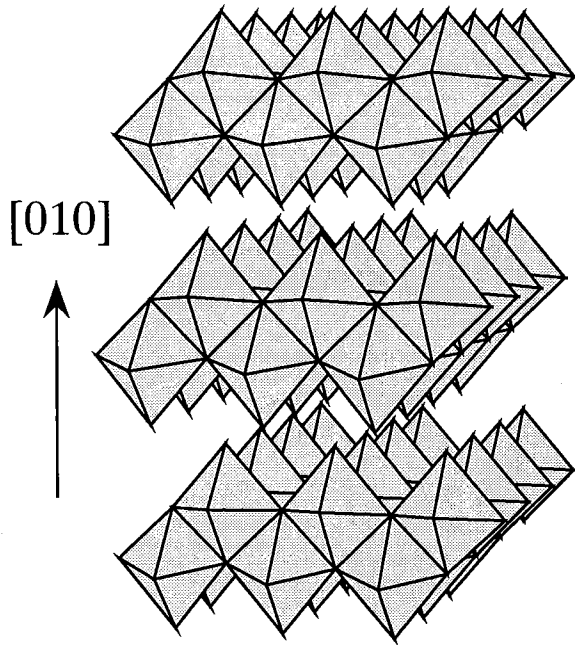

(a)

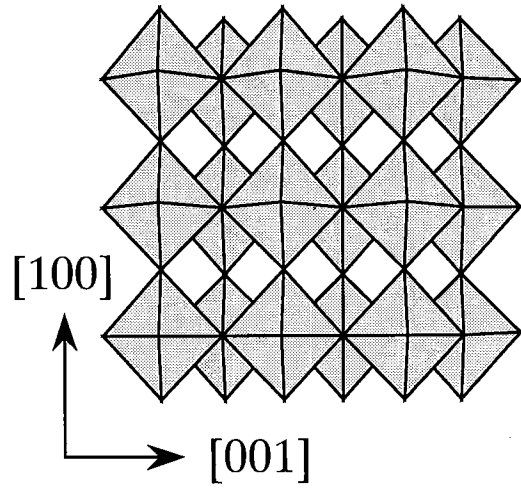

(b)